

Ersatzteile - Spare parts - Pièces de rechange - Reserveonderdelen - Parti di ricambio - Reservedele - Reservodelar Varaosat - Części zamienne - Náhradní díly - Alkatrészek - Piese de schimb - Запасные части - 备件

JUNG PUMPEN MULTISTREAM 150 - 300

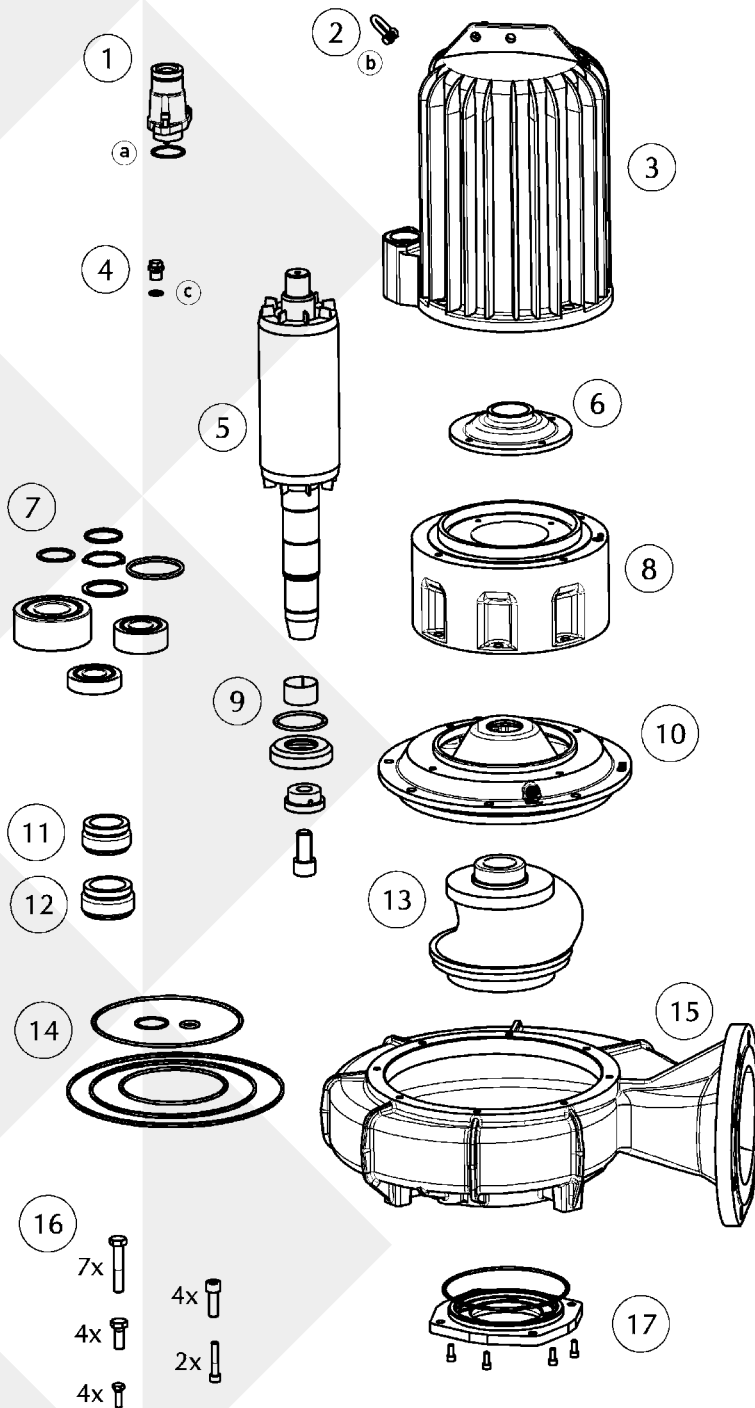

a	10x O-Ring 47x3,5	JP48110
b	10x Splint / Cotter pins 1,6 x 20	JP46182
c	10x O-Ring 10x2,5	JP48088

①	Leitung 150-231 150-231 EX 300 300 EX, 10 M 300 EX, 15 M 300 EX, 20 M 300 EX, 25 M 300 EX, 30 M	Cable	JP47179 JP47180 JP47095 JP47097 JP48157 JP48158 JP48159 JP48160
②	Schäkel	Shackle	JP45904
③	Stator + Gehäuse 150/4, 151/4 200/2 230/4, 231,4 300/2 300/4	Stator + Housing	JP47091 JP47089 JP47092 JP47090 JP47093
④	Ölschraube	Oil screw	JP46046
⑤	Rotorwelle 150/4, 151/4 200/2 230/4, 231,4 300/2 300/4	Rotor shaft	JP47109 JP47110 JP47111 JP47112 JP47113
⑥	Lagerdeckel	Bearing cover	JP47100
⑦	Lagersatz 150-231 300	Bearing set	JP47108 JP47044
⑧	Lagerkammer 200/2, 300/2 150/4 - 300/4	Bearing housing	JP47128 JP47129
⑨	Laufradbefestigung	Impeller fixation	JP47046
⑩	Trennflansch B6 C3, C4, C7 C6	Partition flange	JP47125 JP47126 JP47127
⑪	Gleitringdichtung	Mechanical seal	JP47114
⑫	Gleitringdichtung	Mechanical seal	JP47115
⑬	Laufrad 200/2 B6 300/2 B6 150/4 C3 151/4 C3, 230/4 C3, 230/4 C7 231/4 C4, 300/4 C4, 300/4 C7 150/4 C6 151/4 C6, 230/4 C6 231/4 C6, 300/4 C6	Impeller	JP47117 JP47118 JP47119 JP47120 JP47121 JP47122 JP47123 JP47124
⑭	Dichtungssatz	Seal set	JP47099
⑮	Pumpengehäuse B6 C3, C4 C6 C7	Pump casing	JP47101 JP47102 JP47103 JP47104
⑯	Schraubensatz	Screw set	JP47098
⑰	Schleißring 150/4 C3 151/4 C3, 230/4 C3, C4, C7 B6 C6	Wear ring	JP47105 JP47106 JP47074 JP48108